

# Oneshow



Gelato

170

**H96**

**RAL 9003**

**Fianchi - Pannello frontale - Griglia frontale inferiore**  
**finitura opaca**

Sides - Front panel - Bottom front grille

Matte finish













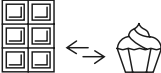











Gelato		Pastry		Chocolate-Pastry	
					
<b>VG RV</b>		<b>VP RV</b>		<b>VCH - VP RV</b>	
					
					



Immagine sopra indicata a solo scopo illustrativo - non contrattuale. L'immagine rappresentata, è puramente indicativa del prodotto finito con fianchi laterali, pannello frontale e griglia frontale inferiore installate.  
Image for illustration purposes only - not contractual. The image shown is purely indicative of the finished product with side panels, front panel and bottom front grille installed.

# Oneshow Allestimenti / Setup

## Vaschette gelato (accessori) Ice cream containers (optionals)

Gelato		120	170
<b>5 lt.</b> 360x165x120H (mm) 		 <b>6</b>	 <b>9</b>
<b>5 lt.</b> 360x250x80H (mm) 		 <b>4</b>	 <b>6</b>
<b>3,5 lt. "Carapina"</b> ø 154x160H (mm) 		 <b>10</b>	 <b>16</b>
<b>Stecchi</b> Ice cream stick 360x250x43H (mm) 		 <b>4</b>	 <b>6</b>
<b>Monoporzioni</b> Single portions 360x250x43H (mm) 		 <b>4</b>	 <b>6</b>

## Vassoi pasticceria Pastry tray

Pastry		120	170
<b>(LxP)</b> (LxD) mm		 <b>1060x400</b>	 <b>1565x400</b>



## Dati tecnici Technical data **UC-B**

Incluso: Fianchi-Pannello frontale-Griglia frontale inferiore  
Included: Sides-Front panel-Bottom front grille



	120	170
<b>Dimensioni esterne (LxPxH) mm</b> External dimensions (LxDxH)	1180x740x960	1685x740x960
<b>Peso (netto) kg</b> Weight (net)	210	280
<b>Refrigerazione</b> Refrigeration	<b>Ventilata</b> Ventilated	
<b>Sbrinamento</b> Defrost	<b>Inversione di ciclo</b> Reverse cycle	
<b>Temperatura di esercizio °C</b> Operating temperature	-20 / +2	
<b>Classe climatica - Condizioni ambientali (°C / %RH)</b> Climate class - Operating conditions	4 (30 / 55)	

## Dati elettrici Electrical data

Modelli con unità condensatrici a bordo - condensazione ad aria  
Models with on-board condensing units - air condensing

<b>Compressore (Quantità - Tipologia)</b> Compressor (Quantity - Type)	<b>1 - Ermetico</b> Hermetic	
<b>Alimentazione elettrica (V / Ph / Hz)</b> Power supply	230 / 1 / 50	
<b>Refrigerante</b> Refrigerant	<b>R290</b>	
<b>Assorbimento elettrico (W / A)</b> Electrical input	a regime nominal	1050 / 5,4
	in sbrinamento defrost	1400 / 6,6
		1270 / 6,4
		1350 / 6,6

## H96

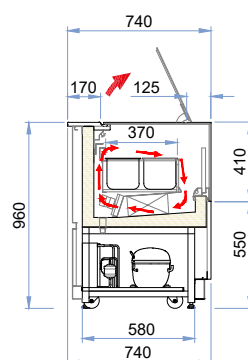
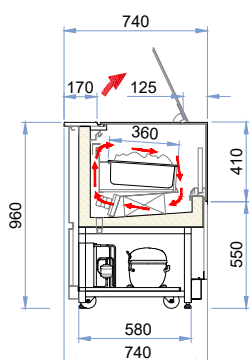



## Dati tecnici Technical data UC-R

Incluso: Fianchi-Pannello frontale-Griglia frontale inferiore  
Included: Sides-Front panel-Bottom front grille

	120	170
<b>Dimensioni esterne (LxPxH) mm</b> External dimensions (LxDxH)	1180x740x960	1685x740x960
<b>Peso (netto) kg - Unità Condensatrice esclusa</b> Weight (net) - Condensing units excluded	180	250
<b>Refrigerazione</b> Refrigeration	<b>Ventilata</b> Ventilated	
<b>Sbrinamento</b> Defrost	<b>Inversione di ciclo</b> Reverse cycle	

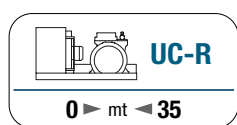

<b>Compressore (Quantità - Tipologia)</b> Compressor (Quantity - Type)	<b>1 - Semi-Ermetico Tropicalizzato</b> Tropicalised Semi_Hermetic						
<b>Refrigerante</b> Refrigerant	<b>R452A</b>						
<b>Dimensioni esterne (LxPxH) mm - UC-R</b> External dimensions (LxDxH)	920x600x380						
<b>Peso (netto) kg</b> Weight (net)	82						
<b>Sbrinamento</b> Defrost	<b>Inversione di ciclo</b> Reverse cycle						
<b>Classe climatica - Condizioni ambientali (°C / %RH)</b> Climate class - Operating conditions	4 (30 / 55)						
<b>Richiesta frigo</b> Heat extraction rate (Ørun) [W@-40 °C]	577						
<b>Alimentazione elettrica V/Ph/Hz</b> Power supply	400 / 3 / 50						
<b>Assorbimento elettrico Unità condensatrice V/A</b> Absorbed power of Condensing unit	3000 / 5,5						
<b>Tubazioni</b> Piping	<table border="0"> <tr> <td><b>Liquida</b> Liquid</td> <td>Ø mm</td> <td>10</td> </tr> <tr> <td><b>Aspirazione</b> Suction</td> <td>Ø mm</td> <td>22</td> </tr> </table>	<b>Liquida</b> Liquid	Ø mm	10	<b>Aspirazione</b> Suction	Ø mm	22
<b>Liquida</b> Liquid	Ø mm	10					
<b>Aspirazione</b> Suction	Ø mm	22					

## H96

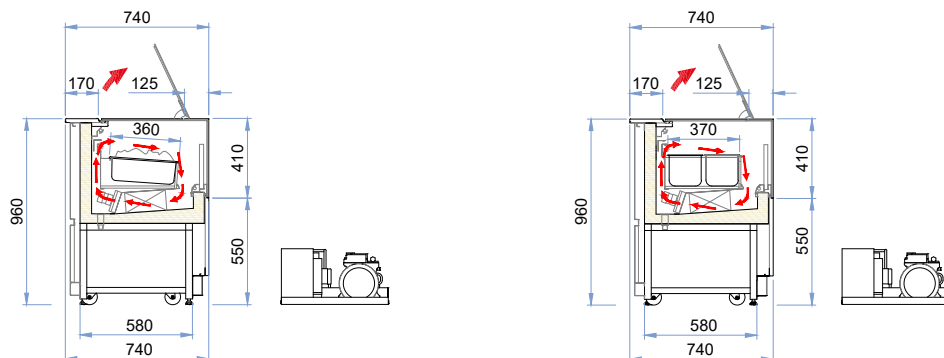



## Dati tecnici Technical data **UC-B**

Incluso: Fianchi-Pannello frontale-Griglia frontale inferiore  
Included: Sides-Front panel-Bottom front grille

	120	170
		
<b>Dimensioni esterne (LxPxH) mm</b> External dimensions (LxDxH)	1180x740x960	1685x740x960
<b>Peso (netto) kg</b> Weight (net)	210	280
<b>Refrigerazione</b> Refrigeration	<b>Ventilata</b> Ventilated	
<b>Sbrinamento</b> Defrost	<b>Fermata compressore</b> Off cycle	
<b>Temperatura di esercizio °C</b> Operating temperature	+1 / +10	
<b>Classe climatica - Condizioni ambientali (°C / %RH)</b> Climate class - Operating conditions	3 (25 / 60)	

## Dati elettrici Electrical data

Modelli con unità condensatrici a bordo - condensazione ad aria  
Models with on-board condensing units - air condensing

<b>Compressore (Quantità - Tipologia)</b> Compressor (Quantity - Type)	<b>1 - Ermetico</b> Hermetic	
<b>Alimentazione elettrica (V / Ph / Hz)</b> Power supply	230 / 1 / 50	
<b>Refrigerante</b> Refrigerant	<b>R290</b>	
<b>Assorbimento elettrico (W / A)</b> Electrical input	a regime nominal	500 / 2,7      600 / 3,3
	in sbrinamento defrost	270 / 1,4      340 / 1,8

## H96

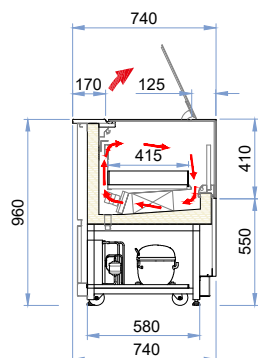



## Dati tecnici Technical data UC-R

Incluso: Fianchi-Pannello frontale-Griglia frontale inferiore  
Included: Sides-Front panel-Bottom front grille

	120	170
<b>Dimensioni esterne (LxPxH) mm</b> External dimensions (LxDxH)	1180x740x960	1685x740x960
<b>Peso (netto) kg - Unità Condensatrice esclusa</b> Weight (net) - Condensing units excluded	180	230
<b>Refrigerazione</b> Refrigeration	<b>Ventilata</b> Ventilated	
<b>Sbrinamento</b> Defrost	<b>Fermata compressore</b> Off cycle	

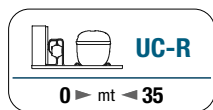

<b>Compressore (Quantità - Tipologia)</b> Compressor (Quantity - Type)	<b>1 - Ermetico</b> Hermetic		
<b>Refrigerante</b> Refrigerant	<b>R452A</b>		
<b>Dimensioni esterne (LxPxH) mm - UC-R</b> External dimensions (LxDxH)	1095x550x380	1110x550x380	
<b>Peso (netto) kg</b> Weight (net)	45	52	
<b>Sbrinamento</b> Defrost	<b>Fermata compressore</b> Off cycle		
<b>Classe climatica - Condizioni ambientali (°C / %RH)</b> Climate class - Operating conditions	3 (25 / 60)		
<b>Richiesta frigo</b> Heat extraction rate (Ørun) [W@-10 °C]	2360	3410	
<b>Alimentazione elettrica V/Ph/Hz</b> Power supply	230 / 1 / 50		
<b>Assorbimento elettrico Unità condensatrice V/A</b> Absorbed power of Condensing unit	1700 / 8,5	1940 / 9,8	
<b>Tubazioni</b> Piping	<b>Liquida</b> Liquid Ø mm	6	8
	<b>Aspirazione</b> Suction Ø mm	14	16

## H96

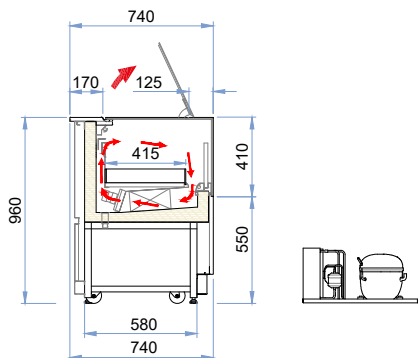

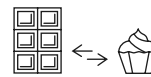

## Dati tecnici Technical data UC-B

Incluso: Fianchi-Pannello frontale-Griglia frontale inferiore  
Included: Sides-Front panel-Bottom front grille

	120	170
 <b>UC-B</b>		
<b>Dimensioni esterne (LxPxH) mm</b> External dimensions (LxDxH)	1180x740x960	1685x740x960
<b>Peso (netto) kg</b> Weight (net)	210	280
<b>Refrigerazione</b> Refrigeration	<b>Ventilata</b> Ventilated	
<b>Sbrinamento</b> Defrost	<b>Fermata compressore</b> Off cycle	
<b>Temperatura di esercizio °C</b> Operating temperature	+14 / +16	
<b>Classe climatica - Condizioni ambientali (°C / %RH)</b> Climate class - Operating conditions	3 (25 / 60)	

## Dati elettrici Electrical data

Modelli con unità condensatrici a bordo - condensazione ad aria  
Models with on-board condensing units - air condensing

<b>Compressore (Quantità - Tipologia)</b> Compressor (Quantity - Type)	<b>1 - Ermetico</b> Hermetic	
<b>Alimentazione elettrica (V / Ph / Hz)</b> Power supply	230 / 1 / 50	
<b>Refrigerante</b> Refrigerant	<b>R290</b>	
<b>Assorbimento elettrico (W / A)</b> Electrical input	<b>a regime nominal</b>	500 / 2,7      610 / 3,3
	<b>in sbrinamento defrost</b>	270 / 1,4      340 / 1,8

## H96

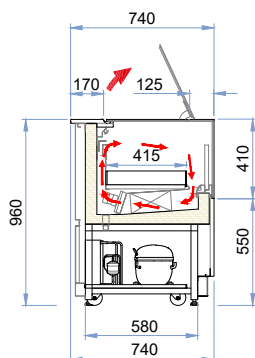

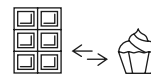

## Dati tecnici Technical data UC-R

Incluso: Fianchi-Pannello frontale-Griglia frontale inferiore  
Included: Sides-Front panel-Bottom front grille

	120	170
<b>Dimensioni esterne (LxPxH) mm</b> External dimensions (LxDxH)	1180x740x960	1685x740x960
<b>Peso (netto) kg - Unità Condensatrice esclusa</b> Weight (net) - Condensing units excluded	180	230
<b>Refrigerazione</b> Refrigeration	<b>Ventilata</b> Ventilated	
<b>Sbrinamento</b> Defrost	<b>Fermata compressore</b> Off cycle	

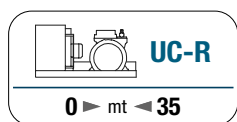

<b>Compressore (Quantità - Tipologia)</b> Compressor (Quantity - Type)	<b>1 - Semi-Ermetico Tropicalizzato</b> Tropicalised Semi_Hermetic		
<b>Refrigerante</b> Refrigerant	<b>R452A</b>		
<b>Dimensioni esterne (LxPxH) mm - UC-R</b> External dimensions (LxDxH)	1095x550x380	1110x550x380	
<b>Peso (netto) kg</b> Weight (net)	45	52	
<b>Sbrinamento</b> Defrost	<b>Fermata compressore</b> Off cycle		
<b>Classe climatica - Condizioni ambientali (°C / %RH)</b> Climate class - Operating conditions	3 (25 / 60)		
<b>Richiesta frigo</b> Heat extraction rate (Ørun) [W@-10 °C]	2360	3410	
<b>Alimentazione elettrica V/Ph/Hz</b> Power supply	230 / 1 / 50		
<b>Assorbimento elettrico Unità condensatrice V/A</b> Absorbed power of Condensing unit	1700 / 8,5	1940 / 9,8	
<b>Tubazioni</b> Piping	<b>Liquida</b> Liquid Ø mm	6	8
	<b>Aspirazione</b> Suction Ø mm	14	16

## H96

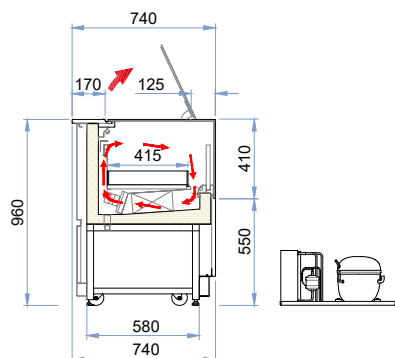

# Oneshow Piante tecniche / Technical plants

Gelato-Pastry • Pastry • Chocolate-Pastry

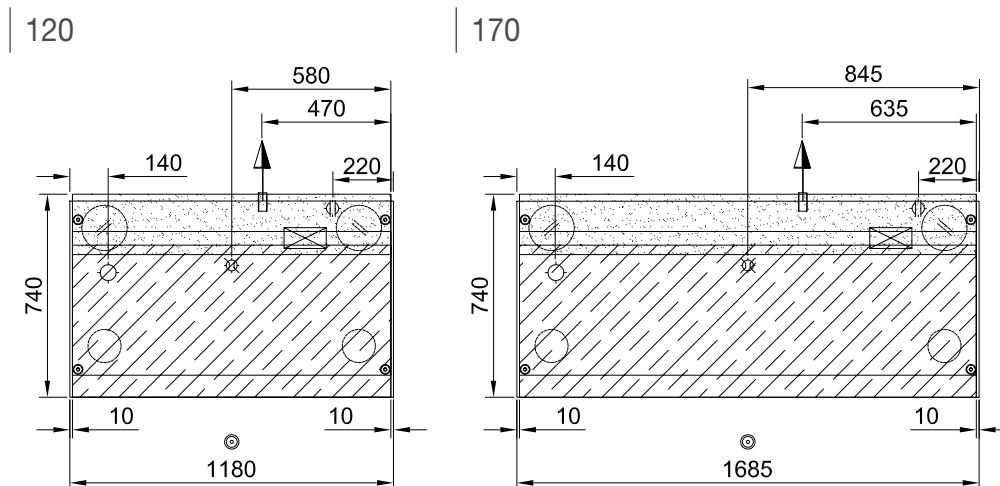

	<b>Piedi appoggio</b>	Support feet		32		<b>Ruota</b>	Wheel
	<b>Scarico</b>	Discharge		Ø int. 25 mm		<b>Ruota con freno</b>	Wheel with brake
	<b>Allacciamento gas</b>	Gas connection		Ø in 8 mm    Ø out 10 mm		<b>Lato cliente</b>	Customer side
	<b>Uscita cavi</b>	Cable output				<b>Passaggio tubi</b>	Pipe passage
	<b>Quadro comandi</b>	Control panel					

## Oneshow Spedizioni / Shipping

**Imballo standard: Pallet + cartone**

Standard packaging: Pallet + carton

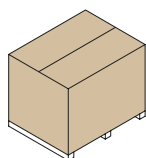

Altezza Height	Modelli Models	Dimensioni esterne - imballo singolo (LxPxH) External dimensions - single packaging (LxDxH)	Volume Volume	Container			Trailer		
				20 ft 5,9 m	40 ft 12 m	HC 12 m	Motrice 9,6 m	Bilico 13,6 m	Mega 13,6 m
H96	120	1280 x 820 x 1120	1,18	20	46	46	36	52	52
	170	1780 x 820 x 1120	1,64	12	26	26	20	30	30